

DTKP

DIGITAL KEYPAD TRANSMITTER

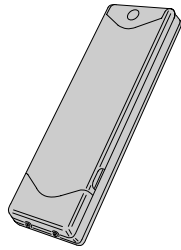

Installation
Instructions

Linear

(800) 421-1587 • www.linearcorp.com

DESCRIPTION

The Delta-3 DTKP Keypad is one of Linear's series of wireless radio controls designed for use with automatic garage door and gate operators. The Delta-3 radio format provides 256 different codes.

In operation, the user enters their unique code on the unit's keypad and presses the START/STOP button to activate the door operator. For up to 30 seconds after the last activation, the DTKP can be re-triggered by simply pressing the START/STOP button again. This allows the user to stop or reverse the opener quickly, without having to re-enter their code.

The DTKP has built-in keypad lighting for use at night or in dark areas. By pressing the START/STOP button first, before entering their code (or pressing START/STOP twice at any time), the user can light up the keypad. The clear silicone keys are backlit with a pleasing green glow.

Standard Digital receivers are programmed by setting an 8-position dipswitch in the receiver. The DTKP will match the receiver's code when the correct number keys are pressed before the START/STOP key. **The correct code for the DTKP matches the "ON" positions of the receiver. The code must be entered in descending order.** Keys 0 and 9 are not used on the DTKP. A keypad lockout timer will disable the keypad after 3 code entry attempts. The keypad must remain idle for 30 seconds before new attempts can be made.

STEP 1 Check receiver's code. Locate the coding dipswitch on the receiver. On some receivers (Model DR) the switch is hidden when the receiver is mounted on the door operator. Loosen the three terminal screws to remove the receiver and examine the coding switch. **From 8 to 1, write down the numbers of all the "ON" switch positions.**

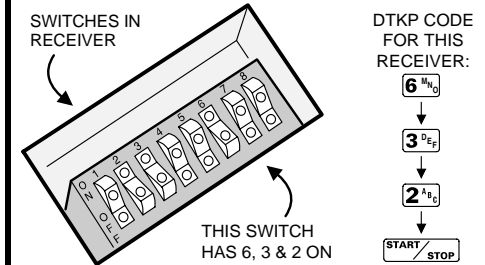

STEP 2 Verify Receiver Installation. Be sure the receiver is reconnected (if removed) to the garage door operator as described in the receiver's Installation Instructions.

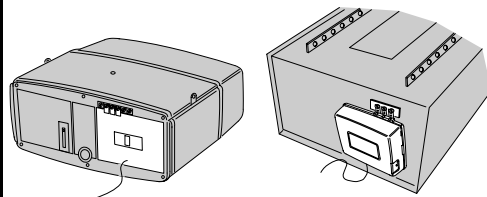

RECONNECT RECEIVER TO GARAGE DOOR OPERATOR

STEP 3 Test receiver. Be sure door area is clear. Try the keypad code. Enter a digit for each receiver switch "ON" position in descending order. The operator should activate when the START/STOP button is pressed after entering the valid keypad code.

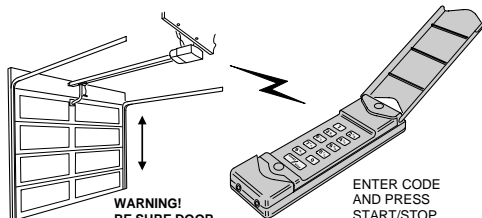

WARNING!
BE SURE DOOR
AREA IS CLEAR
OF OBSTRUCTIONS

ENTER CODE
AND PRESS
START/STOP

STEP 4 Mount keypad. Use the two screws and screw anchors provided to mount the keypad to the wall. Be sure the keypad is at least five feet above the ground. After mounting the keypad, cover the screw heads using the two plugs supplied.

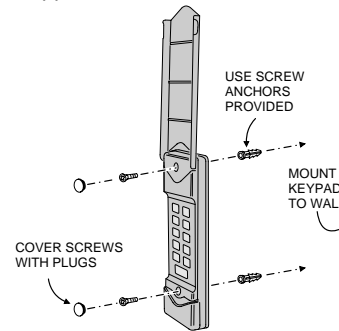

USE SCREW
ANCHORS
PROVIDED

MOUNT
KEYPAD
TO WALL

COVER SCREWS
WITH PLUGS

STEP 5 Operation keystrokes. See the illustration for examples of daytime and nighttime operation.

DAYTIME OPERATION

PRESS: 6^{M₀} → 3^{F₁} → 2^{M₀} → START/STOP

USER'S SECRET CODE

NIGHTTIME OPERATION

PRESS: START/STOP → 6^{M₀} → 3^{F₁} → 2^{M₀} → START/STOP

LIGHTS
KEYPAD

USER'S SECRET CODE

PRESS: START/STOP → START/STOP → LIGHTS
KEYPAD

INFO 1A Opening battery compartment. The DTKP battery should last up to 5 years with normal use. To remove the battery door to replace the battery, remove the battery door retaining screws and slide the battery door off.

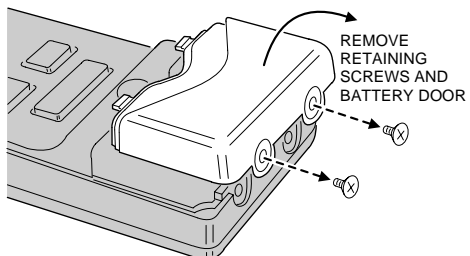

REMOVE
RETAINING
SCREWS AND
BATTERY DOOR

INFO 1B Replacing battery. Remove the low battery and replace it with a fresh 9-volt alkaline or lithium battery. Replace the battery door and retaining screws.

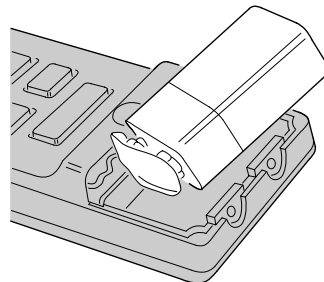

REPLACE
WITH 9-VOLT
ALKALINE OR
LITHIUM
BATTERY ONLY

LIMITED WARRANTY

This product is warranted to the consumer against defects in material and workmanship for one year from the date of purchase. This warranty applies to first retail buyers of new devices. Warrantor will repair, or at its option, replace, any device it finds that requires service under this warranty, and will return the repaired or replaced device to the consumer at the warrantor's cost. For warranty service and shipping instructions contact warrantor at the address shown below. Devices must be sent to warrantor for service at owner's expense. The remedies provided by this warranty are exclusive. Implied warranties under state law are to the one year period of this written warranty. Some states do not allow limitations on how long an implied warranty lasts, so the above limitation may not apply to you. In order to be protected by this warranty, save your proof of purchase and send copy with equipment should repair be required. This warranty gives you specific legal rights, and you may also have other rights which vary from state to state. All products returned for warranty service require a Return Product Authorization Number (RPA#). Contact Linear Technical Services at 1-800-421-1587 for an RPA# and other important details.

IMPORTANT !!!

Linear radio controls provide a reliable communications link and fill an important need in portable wireless signaling. However, there are some limitations which must be observed.

- * For U.S. installations only: The radios are required to comply with FCC Rules and Regulations as Part 15 devices. As such, they have limited transmitter power and therefore limited range.
- * A receiver cannot respond to more than one transmitted signal at a time and may be blocked by radio signals that occur on or near their operating frequencies, regardless of code settings.
- * Changes or modifications to the device may void FCC compliance.
- * Infrequently used radio links should be tested regularly to protect against undetected interference or fault.
- * A general knowledge of radio and its vagaries should be gained prior to acting as a wholesale distributor or dealer, and these facts should be communicated to the ultimate users.